



## Single Output UNR D3 Series

Non-Isolated, 3.3V<sub>IN</sub> to 1.5/1.8/2.5V<sub>OUT</sub>  
8 and 10 Amp DC/DC Converters

### Features

- 3.0-3.6V input range; Non-isolated
- 1.5V, 1.8V or 2.5V output @ 10A
- 2" x 1" through-hole or SMT package
- Gull-wing leads/standard reflow for SMT
- Full synchronous-rectifier topology
- 300kHz switching; Planar magnetics
- High efficiency, to 89%
- Low noise, 80mVp-p
- Quick transient response, 25μsec
- V<sub>OUT</sub> user-trimmable from 1.28V to 3V
- -40 to +50/55°C ambient operation with no derating
- Remote on/off control; Output overcurrent detection
- IEC950/EN60950/UL1950 pending
- EMC compliant

If your DSP and CPLD core logic are demanding more 1.5V, 1.8V or 2.5V current from your 3.3V system, don't pay to derive more isolated power from your intermediate dc bus. DATEL's new, 3.3V-input, UNR "D3" models derive 10 Amps of low-voltage current right from your 3.3V supply. These non-isolated power converters exploit full synchronous rectification, planar magnetics, and 100% automated assembly to deliver high efficiencies (to 89%), low noise (typically 80mVp-p), and low costs. Housed in 1" x 2" shielded metal cases, UNR D3's offer standard through-hole ("T" models) or SMT ("SM" models) packaging.

The new "gull-wing" SMT packages (with metal shells and non-conductive plastic baseplates) weigh less than 40 grams and can withstand peak temperatures up to +235°C. They are compatible with most contemporary pick-and-place and solder-reflow processes.

These versatile DC/DC's are fully line (±0.1% max.) and load (±0.5% max.) regulated. They feature quick transient response (25μsec), user-optional on/off control (for power sequencing), and output overcurrent detection and shutdown ("hiccup" technique with auto-recovery). Their impressive guaranteed efficiencies enable them to deliver fully rated output power from -40 to +50/55°C (ambient) without supplemental cooling.

If your high current requirements have made the use of inefficient linear regulators impractical, take a look at one of DATEL's new switching buck regulators. Their high efficiency, ease-of-use, long-term reliability, and overall cost effectiveness will impress you. Safety agency approvals and EMC characterizations are currently in progress.

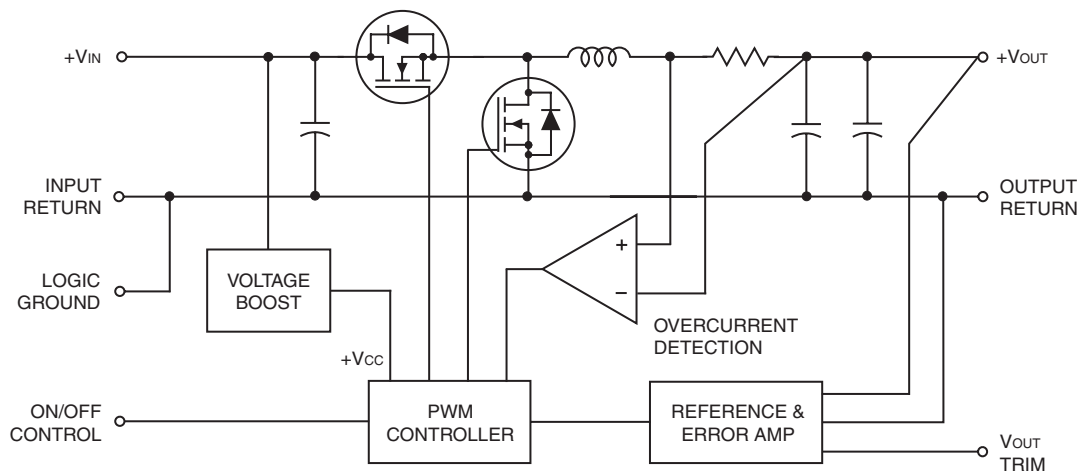

Figure 1. Simplified Schematic

**Performance Specifications and Ordering Guide** <sup>①</sup>

Model	Output				Input			Efficiency		Package (Case, Pinout)		
	V <sub>OUT</sub> (Volts)	I <sub>OUT</sub> (Amps)	R/N (mVp-p) <sup>②</sup>		Regulation (Max.)		V <sub>IN</sub> Nom. (Volts)	Range (Volts)	I <sub>IN</sub> <sup>④</sup> (mA/A)		Min.	Typ.
			Typ.	Max.	Line	Load <sup>③</sup>						
UNR-1.5/10-D3T	1.5	10	80	125	±0.1%	±0.5%	3.3	3.0-3.6	375/5.74	80%	83.5%	C16A2, P23
UNR-1.5/10-D3SM	1.5	10	80	125	±0.1%	±0.5%	3.3	3.0-3.6	375/5.74	80%	83.5%	C18, P25
UNR-1.8/10-D3T	1.8	10	80	125	±0.1%	±0.5%	3.3	3.0-3.6	275/6.38	82.5%	85.5%	C16A2, P23
UNR-1.8/10-D3SM	1.8	10	80	125	±0.1%	±0.5%	3.3	3.0-3.6	275/6.38	83%	85.5%	C18, P25
UNR-2.5/10-D3T	2.5	10	80	125	±0.1%	±0.5%	3.3	3.0-3.6	370/8.51	85%	89%	C16A2, P23
UNR-2.5/10-D3SM	2.5	10	80	125	±0.1%	±0.5%	3.3	3.0-3.6	370/8.51	85%	89%	C18, P25

① Typical at T<sub>A</sub> = +25°C under nominal line voltage and full-load conditions, unless otherwise noted. All models are tested and specified with an external 470µF input capacitor with a 20mΩ ESR and a 6Arms ripple-current rating, as well as a 22µF output capacitor with a 200mΩ ESR. See I/O Filtering and Noise Reduction for more details.

② Ripple/Noise (R/N) is tested/specified over a 20MHz bandwidth. Output noise may be further reduced by installing additional external output caps. See I/O Filtering and Noise Reduction.  
 ③ These devices have no minimum-load requirements and will regulate under no-load conditions.  
 ④ Nominal line voltage, no-load/full-load conditions.

**MECHANICAL SPECIFICATIONS**

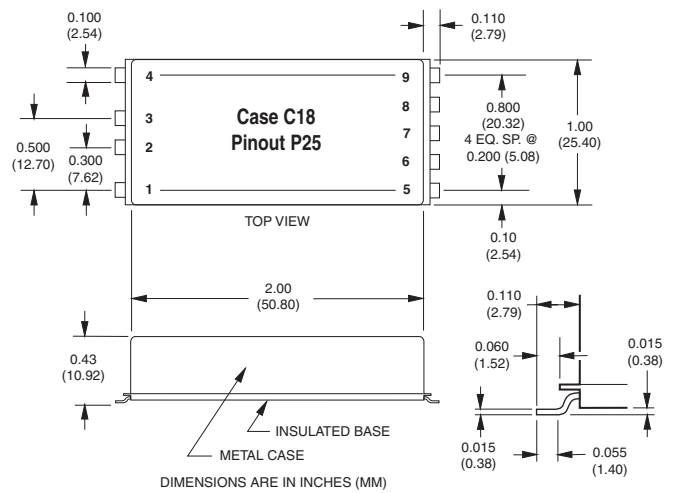
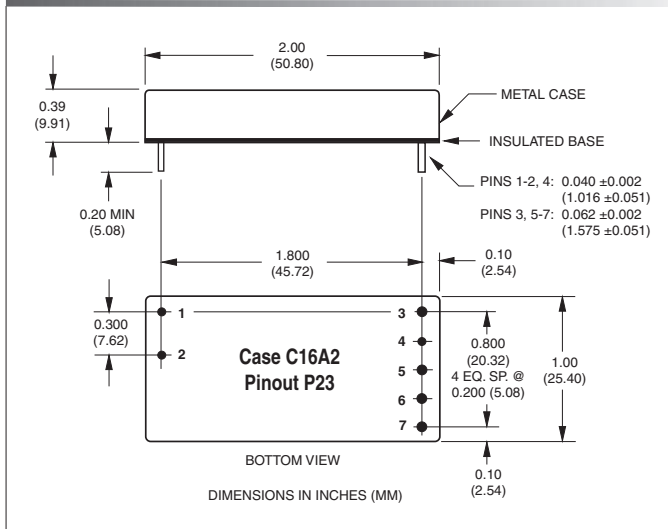

I/O Connections		
Pin	Function P23	Function P25
1	Logic Ground	Logic Ground
2	On/Off Control	On/Off Control
3	+Output	N.C.
4	Trim	N.C.
5	Output Return	+Output
6	Input Return	Trim
7	+Input	Output Return
8	No Pin	Input Return
9	No Pin	+Input

**TEMPERATURE DERATING**

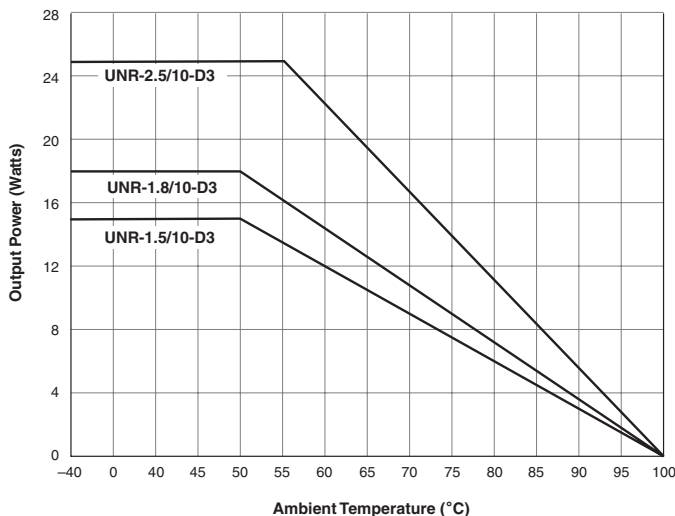

See Temperature Derating section in Technical Notes for more details.

**PART NUMBER STRUCTURE**

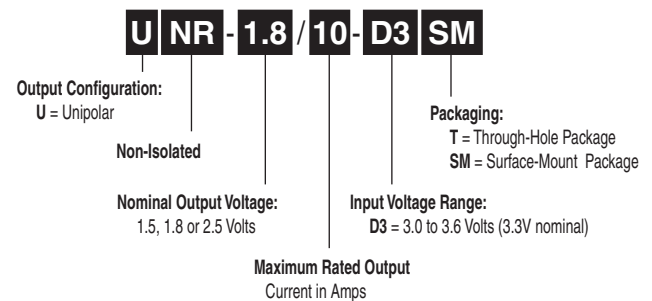

## Performance/Functional Specifications

Typical @ T<sub>A</sub> = +25°C under nominal line voltage and full-load conditions unless noted. ①

Input	
<b>Input Voltage Range</b>	3.0 to 3.6 Volts (3.3V nominal)
<b>Input Current:</b>	
Normal Operating Conditions	See Ordering Guide
Standby/Off Mode	3.6mA typical, 8mA maximum
Output Short Circuited ② ⑥	500mA typical, 700mA maximum
<b>Input Ripple Current:</b>	
UNR-1.5/10-D3, UNR-1.8/10-D3	150mA <sub>p-p</sub>
UNR-2.5/10-D3	50mA <sub>p-p</sub>
<b>Input Filter Type</b>	Capacitive
<b>Overvoltage Protection</b>	None
<b>Reverse-Polarity Protection</b>	None
<b>On/Off Control</b> ③	On = open or 2V to +V <sub>IN</sub> ; I <sub>IN</sub> = 800μA max. Off = 0-0.8V; I <sub>IN</sub> = 1.2mA max.
Output	
<b>V<sub>OUT</sub> Accuracy</b> (50% load):	
UNR-1.5/10-D3	±1% (±15mV) maximum
UNR-1.8/10-D3	±1% (±18mV) maximum
UNR-2.5/10-D3	±1% (±25mV) maximum
<b>V<sub>OUT</sub> Trim Range</b> ④	
Trim pin tied to +Output:	
UNR-1.5/10-D3, UNR-1.8/10-D3	V <sub>OUT</sub> = 1.28 Volts or less
UNR-2.5/10-D3	V <sub>OUT</sub> = 1.52 Volts or less
Trim pin tied to Output Return	V <sub>OUT</sub> = 3.0 Volts or greater
<b>Temperature Coefficient</b>	±0.02% per °C
<b>Ripple/Noise</b> (20MHz BW) ⑤	See Ordering Guide
<b>Line/Load Regulation</b>	See Ordering Guide
<b>Efficiency</b>	See Ordering Guide
<b>Overcurrent Protection:</b> ⑥	
Technique	"Hiccup" with auto-recovery
Overcurrent Detection Point	140% of rated current
Average Output Current	1 Amp typical, 3 Amps maximum
Dynamic Characteristics	
<b>Transient Response</b> (50%-75% step)	25μsec to ±2.5% of final value
<b>Start-Up Time:</b> ⑦	
V <sub>IN</sub> to V <sub>OUT</sub>	25/30msec (1.8/2.5V <sub>OUT</sub> models)
On/Off to V <sub>OUT</sub>	25/30msec (1.8/2.5V <sub>OUT</sub> models)
<b>Switching Frequency</b>	300kHz (±30kHz)
Environmental	
<b>Operating Temperature</b> (Ambient): ⑧	
Without Derating	-40 to +50/55°C
With Derating	to +100°C (See Derating Curves)
<b>Storage Temperature</b>	-40 to +105°C
Physical	
<b>Dimensions:</b>	
Through-Hole Models	2" x 1" x 0.39" (51 x 25 x 9.9mm)
Surface-Mount Models	2" x 1" x 0.43" (51 x 25 x 10.9mm)
<b>Shielding</b>	5 sided
<b>Case Connection</b>	Input/Output Return
<b>Case Material</b>	Corrosion-resistant steel with non-conductive epoxy-based black enamel finish and plastic base plate
<b>Pin Material</b>	Copper, tin plated
<b>Weight</b>	1.4 ounces (39.7 grams)

- ① All models are tested and specified with an external 470μF input capacitor with a 20mΩ ESR and a 6Arms ripple-current rating, as well as a 22μF output capacitor with a 200mΩ ESR. See I/O Filtering and Noise Reduction for more details. These devices have no minimum-load requirements and will regulate under no-load conditions. Listed specifications apply for both "T" and "SM" models as appropriate.
- ② See Output Overcurrent Detection for details.
- ③ See On/Off Control for details.
- ④ See Output Voltage Trimming for details.
- ⑤ For all models, output noise can be further reduced with the installation of additional external output capacitors. See I/O Filtering and Noise Reduction for details.
- ⑥ Output overcurrent detection initiates at approximately 40% above rated load (14 Amps). Under overload or short-circuit conditions, output current "hiccups" at approximately 1 Amp average and remains at that level until the overload is removed. See Output Overcurrent Detection.
- ⑦ See Start-Up Time for details.
- ⑧ See Temperature Derating for details.

## Absolute Maximum Ratings

<b>Input Voltage:</b>	
Continuous	5 Volts
Transient (100msec)	6.3 Volts
<b>Input Reverse-Polarity Protection</b>	None
<b>Input/Output Overvoltage Protection</b>	None
<b>Output Current</b>	Current limited. Devices can withstand a sustained output short circuit without damage.
<b>Storage Temperature</b>	-40 to +105°C
<b>Lead Temperature</b> (Soldering, 10 sec.)	+300°C

These are stress ratings. Exposure of devices to any of these conditions may adversely affect long-term reliability. Proper operation under conditions other than those listed in the Performance/Functional Specifications Table is not implied.

## TECHNICAL NOTES

## Return Current Paths

These are non-isolated DC/DC converters. The Input Return, Output Return and Logic Ground pins are all connected together internally. To the extent possible, all input and load currents should be returned through the Input Return and Output Return, respectively (via low-impedance runs). Any control signals applied to the On/Off Control pin should be referenced to Logic Ground. The internal trace leading to Logic Ground is not designed to carry high current. Consequently, devices should never be installed in a manner that results in high current flow through Logic Ground (i.e., the Input/Output Return pins should never be left open or connected via high-impedance paths).

## I/O Filtering and Noise Reduction

All UNR 15-25W Series converters are tested and specified with external 470μF input capacitors (20mΩ ESR, 6Arms ripple-current rating) and external 22μF output capacitors (200mΩ ESR). External input capacitance is required and must be rated to handle the input ripple current as follows:

$$I_{RMS} = I_{OUT} \sqrt{\frac{V_{OUT}}{V_{IN}} \left(1 - \frac{V_{OUT}}{V_{IN}}\right)}$$

In critical applications, input/output ripple/noise may be further reduced by installing additional I/O caps.

External input capacitors serve primarily as energy-storage elements. They should be selected for bulk capacitance (at appropriate frequencies), low ESR, and high rms-ripple-current ratings. The switching nature of modern DC/DC converters requires that dc input voltage sources have low ac impedance, and highly inductive source impedances can affect system stability. Your specific system configuration may necessitate additional considerations.

Output ripple/noise (also referred to as periodic and random deviations or PARD) can be reduced below specified limits using filtering techniques, the simplest of which is the installation of additional external output capacitors. Output capacitors function as true filter elements and should be selected for bulk capacitance, low ESR, and appropriate frequency response. Any scope measurements of PARD should be made directly at the DC/DC output pins with scope probe ground less than 0.5" in length.

All external capacitors should have appropriate voltage ratings and be located as close to the converters as possible. Temperature variations for all relevant parameters should be taken into consideration.

The most effective combination of external I/O capacitors will be a function of your line voltage and source impedance, as well as your particular load and layout conditions. Our Applications Engineers can recommend potential solutions and discuss the possibility of our modifying a given device's internal filtering to meet your specific requirements. Contact our Applications Engineering Group for additional details.

### Input Fusing

UNR 15-25W D3 Series DC/DC converters are not internally fused. Certain applications and or safety agencies may require the installation of fuses at the inputs of power conversion components. For DATEL UNR D3 Series DC/DC converters, you should use either slow-blow or normal-blow fuses with values no greater than the following.

Output Voltage	Fuse Value
1.5V Models	11 Amps
1.8V Models	12 Amps
2.5V Models	18 Amps

### Input Overvoltage and Reverse-Polarity Protection

UNR D3 Series DC/DC converters do not incorporate either input overvoltage or input reverse-polarity protection. Input voltages in excess of the listed absolute maximum ratings and input polarity reversals of longer than "instantaneous" duration can cause permanent damage to these devices.

### On/Off Control

The On/Off Control pin may be used for remote on/off operation. UNR D3 Series DC/DC converters are designed so that they are enabled when the control pin is pulled high or left open (normal mode) and disabled when the control pin is pulled low (to less than +0.8V relative to Logic Ground). As shown in Figure 2, both 2.5V<sub>OUT</sub> and 1.8V<sub>OUT</sub> models have internal 1k $\Omega$  pull-up resistors to V<sub>IN</sub> (+Input).

Dynamic control of the on/off function is best accomplished with a mechanical relay or open-collector/open-drain drive circuit. The drive circuit should be able to sink appropriate current when activated and withstand appropriate voltage when deactivated.

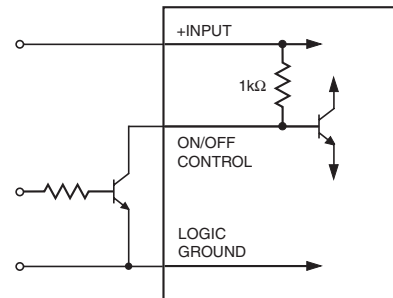

Figure 2. Driving the On/Off Control Pin

Applying an external voltage to the On/Off Control pin when no input power is applied to the converter can cause permanent damage to the converter. The on/off control function, however, is designed such that the converter can be disabled (control pin pulled low) while input power (system 3.3V power) is ramping up and then "released" once the input has stabilized. The time duration between the point at which the converter is released and its fully loaded output settles to within specified accuracy can be found in the Performance/Functional Specifications Table. See Start-Up Time for more details.

### Start-Up Time

The V<sub>IN</sub> to V<sub>OUT</sub> Start-Up Time is the interval between the time at which a ramping input voltage crosses the lower limit of the specified input voltage range (3.0 Volts) and the fully loaded output voltage enters and remains within its specified accuracy band. Actual measured times will vary with input source impedance, external input capacitance, and the slew rate and final value of the input voltage as it appears to the converter.

The On/Off to V<sub>OUT</sub> Start-Up Time assumes the converter is turned off via the Remote On/Off Control with the nominal input voltage already applied to the converter. The specification defines the interval between the time at which the converter is turned on and the fully loaded output voltage enters and remains within its specified accuracy band. See Typical Performance Curves for details.

### Output Overvoltage Protection

UNR D3 Series DC/DC converters do not incorporate output overvoltage protection. In the extremely rare situation in which the device's feedback loop is broken, the output voltage may run to excessively high levels (V<sub>OUT</sub> = V<sub>IN</sub>). If it is absolutely imperative that you protect your load against any and all possible overvoltage situations, voltage limiting circuitry must be provided external to the power converter.

### Output Overcurrent Detection

Overloading the output of a power converter for an extended period of time will invariably cause internal component temperatures to exceed their maximum ratings and eventually lead to component failure. High-current-carrying components such as inductors, FET's and diodes are at the highest risk. UNR D3 Series DC/DC converters incorporate an output overcurrent detection and shutdown function that serves to protect both the power converter and its load.

When the output current of a thermally stabilized converter exceeds the maximum rating (10A) by 40% (typical) to 80% (maximum), the internal overcurrent detection circuit automatically shuts down the converter by discharging the soft-start circuit of the pulse width modulator (PWM). In this off state, which is similar to that achieved by pulling the On/Off Control low, the output voltage quickly drops as the output capacitors discharge into the load. Since there is no longer any output current, the overcurrent detection circuit is released, allowing the soft-start circuit to recharge and the converter to turn on again. If the faulty load condition persists, the overcurrent detection circuit will again discharge the soft-start circuit and shut down the converter. This continuous on/off cycling of the converter is referred to as "hiccup mode." Once the overload condition is removed, the converter remains on, and the output voltage is quickly restored to its regulated value.

The components used to sense the output current have large temperature coefficients. Consequently, in a "cold-start" situation, the Overcurrent Detection Point may temporarily move to 80% to 120% above the rated current specification. The device quickly heats up, particularly if an overload situation exists, and restores the normal (40%) Overcurrent Detection Point. The device easily survives starting up into an output-short-circuit condition.

The overcurrent detection circuitry helps keep internal current levels and operating temperatures within safe operating limits. Nevertheless, sustained operation at current levels above the rated output current (10 Amps) but below the Overcurrent Detection Point (typically 14 Amps) may result in permanent damage to the converter (unless active cooling keeps internal temperatures below safe limits).

**Output Voltage Trimming**

For 2.5V<sub>OUT</sub> devices, the output can be trimmed to any voltage between 1.52V and 3.0V. For 1.5V<sub>OUT</sub> and 1.8V<sub>OUT</sub> devices, the output can be trimmed to any voltage between 1.28V and 3.0V. Trimming is accomplished with either a trimpot or a single fixed resistor. The trimpot should be connected between +Output and Output Return with its wiper connected to the Trim pin as shown in Figure 3 below.

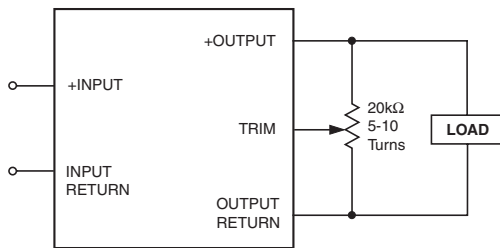

**Figure 3. Trim Connections Using a Trimpot**

A trimpot can be used to determine the value of a single fixed resistor which should be connected, as shown in Figure 4, between the Trim pin and +Output to trim down the output voltage, or between the Trim pin and Output Return to trim up the output voltage. Fixed resistors should be metal-film types with absolute TCR's less than 100ppm/°C to ensure stability.

The equations and look-up table below can be used as starting points for selecting specific trim-resistor values. Recall that untrimmed devices are guaranteed to be ±1% accurate.

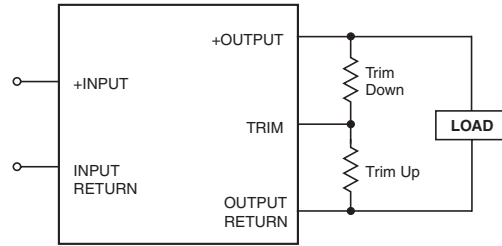

**Note:** Install either a fixed trim-up resistor or a fixed trim-down resistor depending upon desired output voltage.

**Figure 4. Trim Connections Using Fixed Resistors**

**Trim-Resistor Equations for 2.5V<sub>OUT</sub> Devices**

$$V_{OUT} = V_{OUT \text{ Desired}}$$

$$\text{Trim Down } R_{TRIM} \text{ (Ohms)} = \frac{7500 (V_{OUT} - 1.267)}{2.5 - V_{OUT}} - 1740$$

$$\text{Trim Up } R_{TRIM} \text{ (Ohms)} = \frac{9465}{V_{OUT} - 2.5} - 1740$$

**Trim-Resistor Equations for 1.8V<sub>OUT</sub> Devices**

$$V_{OUT} = V_{OUT \text{ Desired}}$$

$$\text{Trim Down } R_{TRIM} \text{ (Ohms)} = \frac{2670 (V_{OUT} - 1.267)}{1.8 - V_{OUT}}$$

$$\text{Trim Up } R_{TRIM} \text{ (Ohms)} = \frac{3380}{V_{OUT} - 1.8}$$

**Trim-Resistor Look-Up Table for Common Output Voltages**

Desired Output Voltage (Volts)	1.8V <sub>OUT</sub> Models		2.5V <sub>OUT</sub> Models	
	Trim Resistor (Ω)	Connect To	Trim Resistor (Ω)	Connect To
1.28	0	+Output	N.A.	N.A.
1.52	2.07k	+Output	0	+Output
1.8	Open	Open	4.03k	+Output
2	16.9k	-Output	9.35k	+Output
2.5	4.83k	-Output	Open	Open
2.8	3.38k	-Output	29.7k	-Output
3	2.82k	-Output	17.15k	-Output

**Temperature Derating**

The outstanding electrical efficiency of the UNR D3 Series' synchronous-rectifier design and the excellent thermal conductivity of its encapsulated metal package combine to eliminate the need for heat sinking or supplemental forced-air cooling in the majority of routine applications. As shown in the derating curves on page 2, 2.5V<sub>OUT</sub> models deliver full rated output power (25 Watts) up to +55°C (ambient) and then derate linearly to +100°C. 1.8V<sub>OUT</sub> models deliver full rated output power (18 Watts) up to +50°C (ambient) and similarly derate linearly to +100°C.



**Recommended PC Board Layout**

If necessary, a single pc board layout can accommodate both through-hole and SMT models of the UNR D3 Series. Note that on page 2 of this data sheet, the through-hole package is drawn with a bottom view of its pin locations, and the surface-mount package is drawn with of top view of its pin locations. As shown below, the through-hole pin locations, when viewed from above, fall just inside (on 1.8 inch centers) the SMT pin locations (which essentially begin on 2.1 inch centers). The table below shows how the pin functions align.

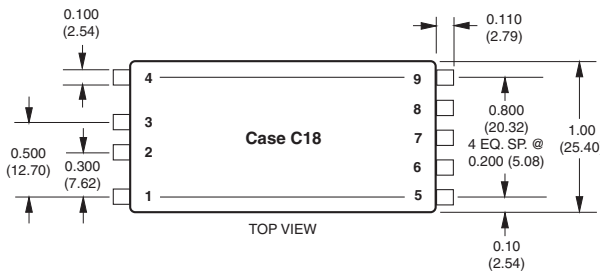
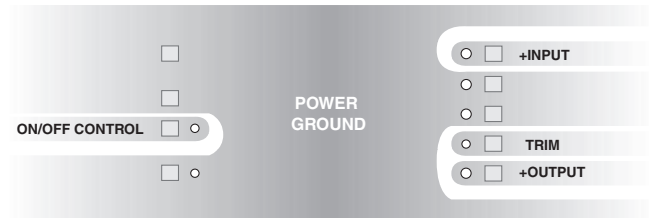
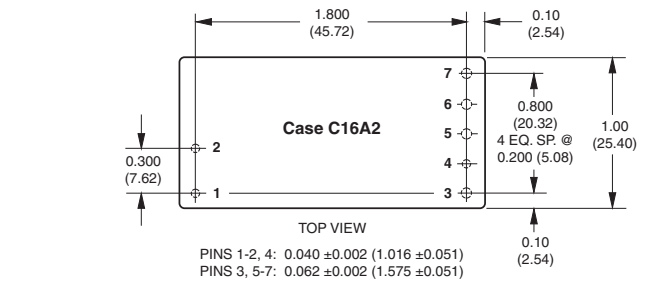

SMT Pin Number	Through-Hole Pin Number	Pin Function
4	No Pin	N.C.
3	No Pin	N.C.
2	2	On/Off Control
1	1	Logic Ground
9	7	+Input
8	6	Input Return
7	5	Output Return
6	4	Trim
5	3	+Output

**Figure 5. Recommended Board Layout**

**SMT Solder Process for SM models**

For the surface-mount "SM" models of the UNR Series, the packages' gull-wing leads are made of tin-plated (150 microinches) copper. The gull-wing configuration, as opposed to "J" leads, was selected to keep the solder joints out from under the package to minimize both, heat conduction away from the leads (into the encapsulated package) and shadowing effects.

"SM" modules do not currently withstand the standard solder-reflow process with its most common temperature profiles. In order to avoid damage to the converter a selective solder process (i.e. hot air gun or a hand soldering method) with the following parameters must therefore be chosen :

Pre-heat phase 30-60°C rise/minute to 150°C maximum.

Lead temperature 300°C for 10 seconds maximum.

As shown in Figure 6, our tests have determined the optimal landing-pad size to be 160 mils by 130 mils (4 x 3.3 mm).

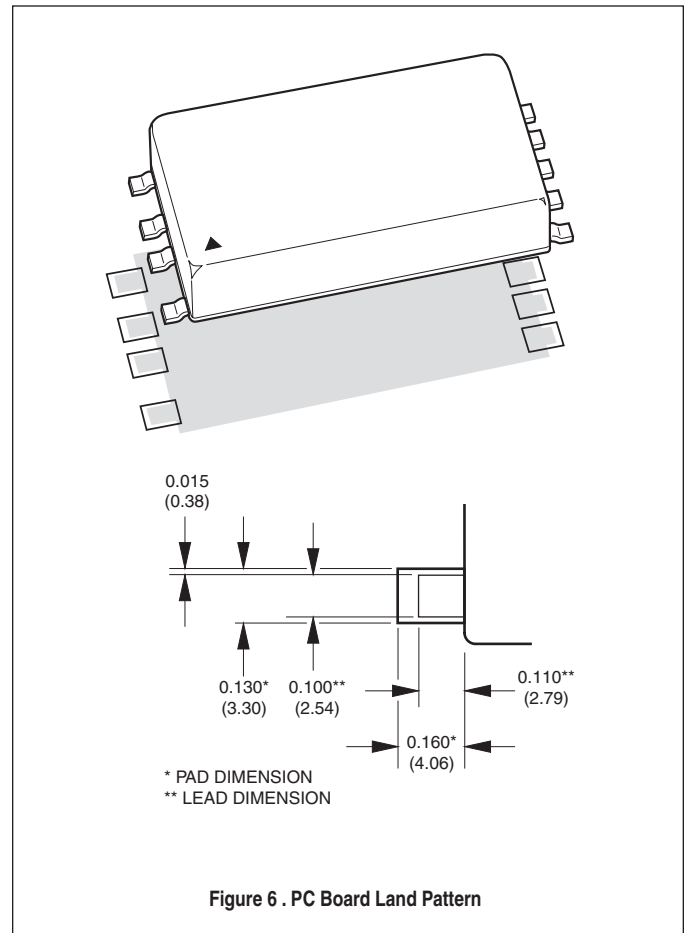
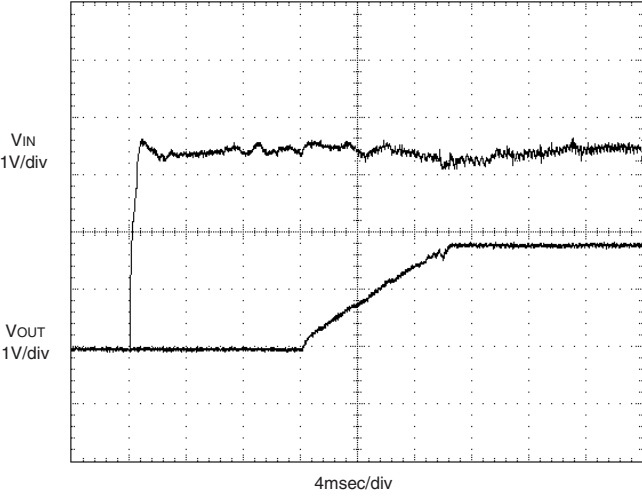

**Figure 6 . PC Board Land Pattern**

TYPICAL PERFORMANCE CURVES

**V<sub>IN</sub> to V<sub>OUT</sub> Start-Up Time**

**UNR-1.8/10-D3 Models**  
(V<sub>IN</sub> = 3.3V, I<sub>OUT</sub> = 10A, 22μF output capacitor.)



**UNR-2.5/10-D3 Models**  
(V<sub>IN</sub> = 3.3V, I<sub>OUT</sub> = 10A, 22μF output capacitor.)

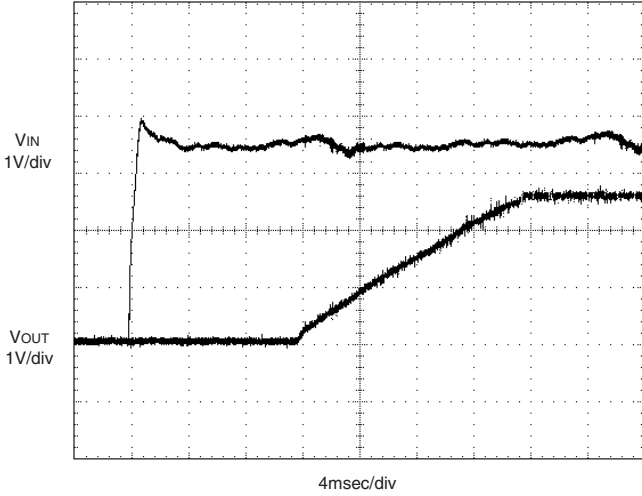

**On/Off Control to V<sub>OUT</sub> Start-Up Time**

**UNR-1.8/10-D3 Models**  
(V<sub>IN</sub> = 3.3V, I<sub>OUT</sub> = 10A, 22μF output capacitor.)

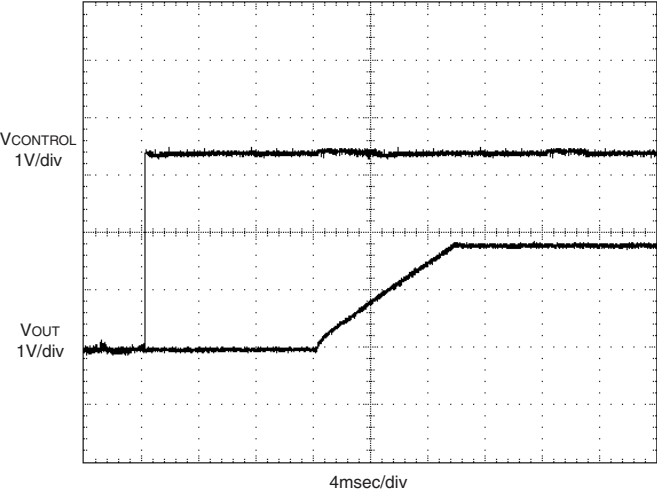

**UNR-2.5/10-D3 Models**  
(V<sub>IN</sub> = 3.3V, I<sub>OUT</sub> = 10A, 22μF output capacitor.)

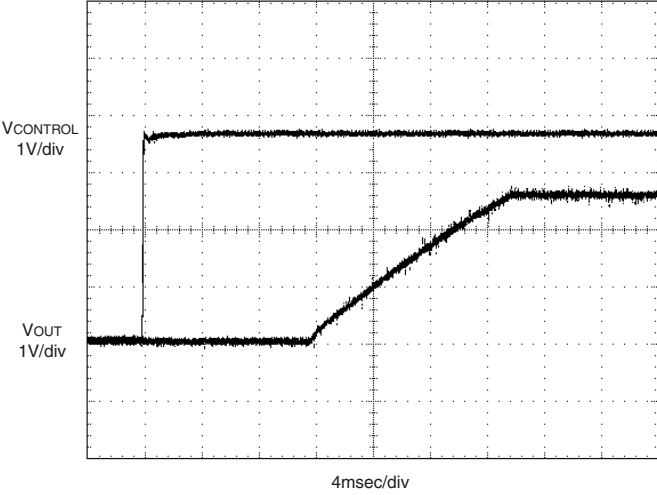

TYPICAL PERFORMANCE CURVES

**Efficiency vs. Output Current and Input Voltage**

**UNR-1.5/10-D3 Models**

(Guaranteed efficiency = 80% at  $V_{IN} = 3.3V$  and  $I_{OUT} = 10A$ )

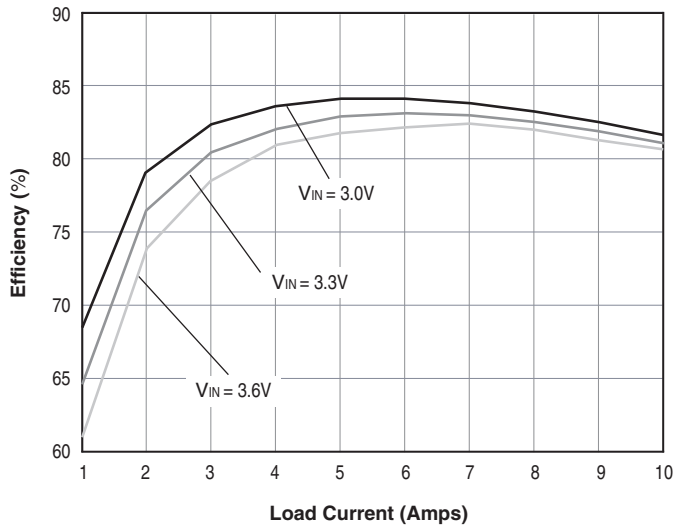

**UNR-2.5/10-D3 Models**

(Guaranteed efficiency = 85% at  $V_{IN} = 3.3V$  and  $I_{OUT} = 10A$ )

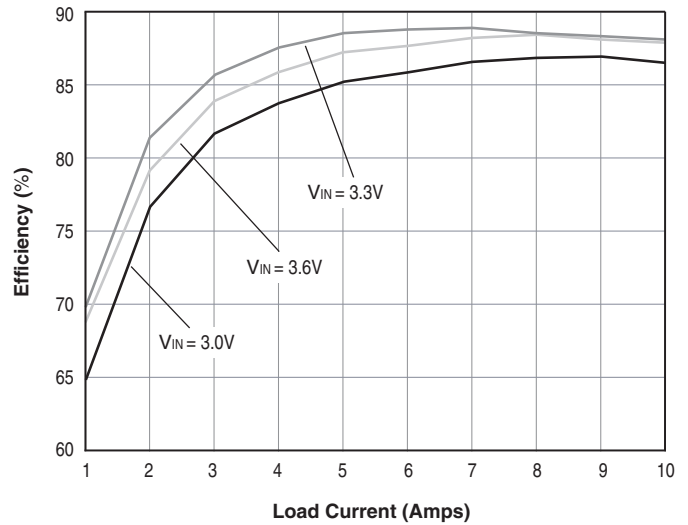

**UNR-1.8/10-D3 Models**

(Guaranteed efficiency = 82.5% at  $V_{IN} = 3.3V$  and  $I_{OUT} = 10A$ )

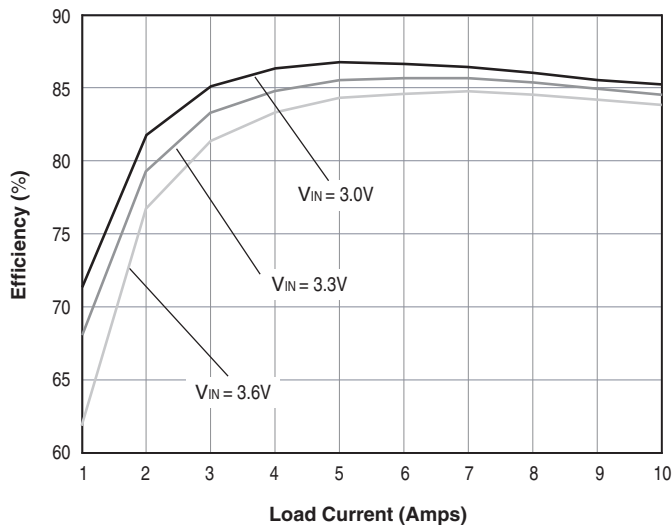

CUSTOM CAPABILITIES

DATEL's world-class design, development and manufacturing team stands ready to work with you to deliver the exact power converter you need for your demanding, large volume, OEM applications. And . . . we'll do it on time and within budget!

Our experienced applications and design staffs; quick-turn prototype capability; highly automated, SMT assembly facilities; and in-line SPC quality-control techniques combine to give us the unique ability to design and deliver any quantity of power converters to the highest standards of quality and reliability.

We have compiled a large library of DC/DC designs that are currently used in a variety of datacom/telecom, medical, computer, railway, aerospace and industrial applications. We may already have the converter you need.

Contact us. Our goal is to provide you the highest-quality, most cost-effective power converters available.



ISO 9001 REGISTERED

DS-0520A 10/02

DATEL, Inc. 11 Cabot Boulevard, Mansfield, MA 02048-1151  
 Tel: (508) 339-3000 (800) 233-2765 Fax: (508) 339-6356  
 Internet: www.datel.com Email: sales@datel.com

DATEL (UK) LTD. Tadley, England Tel: (01256)-880444  
 DATEL S.A.R.L. Montigny Le Bretonneux, France Tel: 01-34-60-01-01  
 DATEL GmbH München, Germany Tel: 89-544334-0  
 DATEL KK Tokyo, Japan Tel: 3-3779-1031, Osaka Tel: 6-354-2025

DATEL makes no representation that the use of its products in the circuits described herein, or the use of other technical information contained herein, will not infringe upon existing or future patent rights. The descriptions contained herein do not imply the granting of licenses to make, use, or sell equipment constructed in accordance therewith. Specifications are subject to change without notice. The DATEL logo is a registered DATEL, Inc. trademark.